





Montaj Kılavuzu • Mounting Instructions

CB 125/250 R 2018-2020 Uyumlu Arka Çanta Demiri • CB 125/250 R 2018-2020 Compatible Rear Rack

No	Adet Qty.	Parça • Parts	No	Adet Qty.	Parça • Parts
A	1 x	 (Çanta Demiri) (Rear Rack)	D	2 x	 (M10 Kalın Pul) (M10 Thick Flake)
B	4 x	 (6x35 Bombe B. Civata) (6x35 Bolt)	E	2 x	 (Havşa B. Pul) (Flake)
C	2 x	 (8x25 Havşa B. Civata) (8x25 Bolt)			

Gerekli Aletler • Required Tools



(5 Alyan) • (#5 Allen)



(4 Alyan) • (#4 Allen)

Montaj Talimatları

1- Aşama 1'de gösterilen civataları sökün ve artçı ayaklıkları çıkarın.

Mounting Instructions

1- Unscrew the bolts shown in step 1 and remove the rear feet.

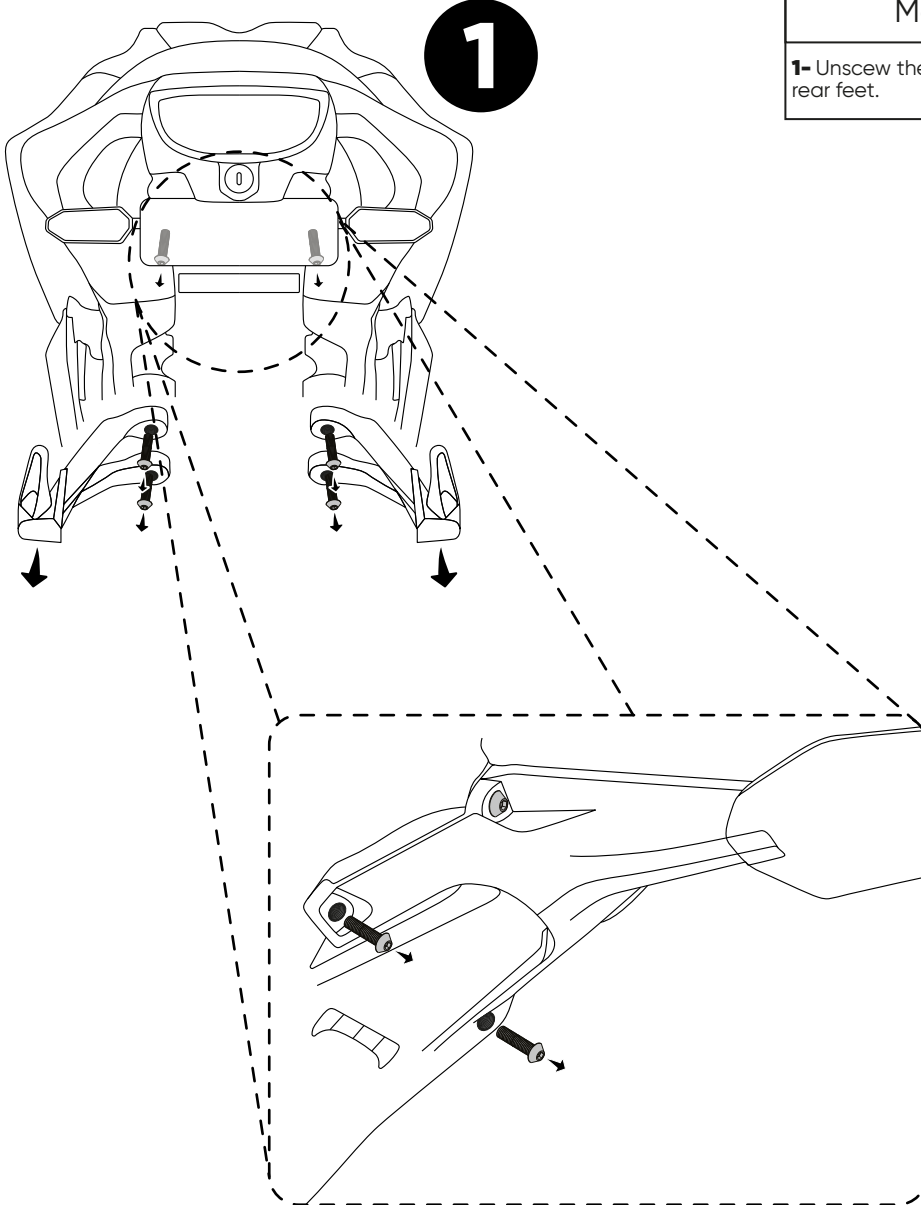

2

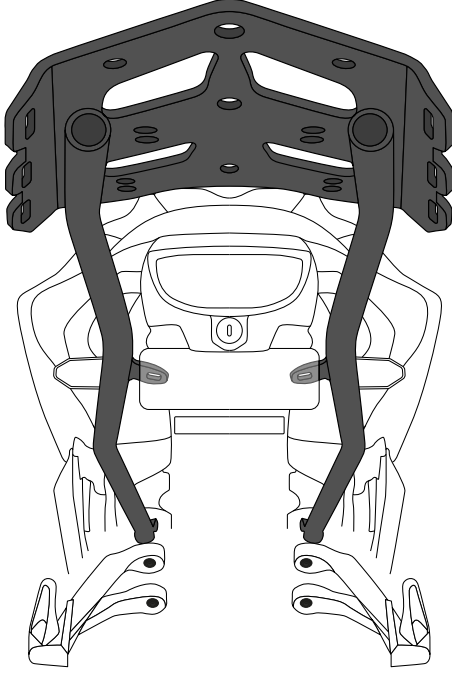

Montaj Talimatları

2- Çanta demirini aşama 2'de gösterildiği gibi konumlandırın.

3- Çanta demirinin üst tarafını havşa pul ve 6x35 havşa başlı civata ile sabitleyin.

4- Çanta demirinin alt tarafındaki bağlantı noktalarını artçı ayaklığının üst yuvalarına konumlandırın ve ayaklıkları demirin üstüne getirin ve 8x25 bombe başlı civatayla sabitleyin. Ayaklıkların alt tarafını monte ederken M10 kalın pulları ayakla yuva arasına koyun.

Mounting Instructions

2- Position the rear rack as shown in step 2. and it.

3- Fix the upper side of the rear rack with countersunk flanges and 6x35 countersunk head bolt.

4- Position the anchor points on the underside of the rear rack into the upper slots of the rear foot. Position the footrest on the rear rack and fix them with 8x25 camber head bolts. When assembling the underside of the footrest, put the M10 thick washers between the pedestal and the housing.

3

